



**TARIK KHAN**  
Proprietor  
(MBA. BE)

PROMISES MADE.PROMISES KEPT.  
**Skill and Passion**

# Track and Trace-Red

Branch Offices : Mumbai, Ahmedabad, Varanasi



**Client**  
**Project**

 C-106, Kailas Business Park, Park Site, Veer Savarkar Marg,  
Vikhroli West Pin -400079

 +91 8070971677 +91 8591078436

 [tarikk.tnt@gmail.com](mailto:tarikk.tnt@gmail.com)





# Track and Trace-Red

## INTRODUCTION

### CLASS 'A' LICENSED FIRE FIGHTING & PLUMBING CONTRACTOR

Dear Sir,

We would like to take this opportunity to introduce ourselves as a company involved in the business of MEP

We undertake all types of Plumbing & Fire Fighting works (Such as sanitary, Internal & External water supply, heavy drainage works internal and external drainage system, swimming pool system, heavy water supply, heavy water treatment system, Fitting Sprinklers, Main line, Branches, routing PEB – INTERIOR WINDOW – CIVIL STRUCTURE etc) and other related works.

We are backed up with a team of skilled and experienced professionals to handle all major projects, including liaising with all Government offices and other formalities. Presently we are extending these services to various Govt. organizations, public and private sectors.

Please find enclosed herewith our Brochure, which proves our credibility in the above fields.

We now request you to kindly register our name as MEP & Civil Interior Contractor in your esteemed organization and forward your valuable enquiries to us to submit our competitive offer.

If there is anything more we could do for you, please do not hesitate to write to us. We at **TRACK AND TRACE-RED** assure you for the best services at all times.



# Track and Trace-Red

## ABOUT US



**Chairman - ManUFACTURING**  
**Dr. A. Khan - CMO**  
**Chief Medical Officer**



**Founder**  
**20 Years Experience in Industry**

**TRACK AND TRACE-RED** was founded in the year 2022 and started the business as sole trading concern by **MR. TARIK KHAN** with the clear object of **PROMOTING** and **COMMITMENT** to Quality **MEP** of **TOPMOST STANDARDS AND SAFE-CONSTRUCTION PRACTICES** is critical to success, but we proudly say that we have achieved success in the last **5 Five Years**

The hard and sincere way, by which the Company has achieved its present status due to the great contribution from **MR. TARIK KHAN**, the founder of this Organization.

Natio **T & T** is Head quartered in Mumbai and having main branch office in Chennai, is professionally managed by a team of qualified professionals.

**Service**

deserve.

*"We believe in Quality Services"*



# Track and Trace-Red

## VISION – MISSION – VALUES

### VISION

To be the service provider of choice for our customers through constant innovation, assured quality and efficient

### MISSION

Our mission is to be a trusted partner providing comprehensive and reliable services to add value to our clients and create an environment for growth of all stakeholders

### VALUES

**Customer Focus**

**Quality**

**Ethical Business Practices**

**Learning and Innovation**

# Track and Trace-Red

## AWARDS



# Track and Trace-Red

## OUR VALUED CLIENTS

<p><b>Renaissance Industrial Smart City</b></p>	
<p><b>Zhangjiagang Apollo Machinery Co.,Ltd</b></p>	
<p><b>JMS INTERNATIONAL SCHOOL</b></p>	
<p><b>ms international public school &amp; coaching</b></p>	
<p><b>Hari Bandhu International School</b></p>	
<p><b>Nanavati Max Super Speciality Hospital</b></p>	



# Track and Trace-Red







## OUR VALUED CLIENTS

<p><b>Larsen &amp; Toubro</b></p>	
<p><b>Hotel Pride Plaza Ahmedabad</b></p>	
<p><b>Jw Marriott Juhu</b></p>	
<p><b>Intensity Gym</b></p>	
<p><b>mcdonald</b></p>	
<p><b>dynamix group</b></p>	



# Track and Trace-Red

## OUR VALUED CLIENTS

<b>Classic Marble Company</b>	
<b>Oberoi Realty</b>	
<b>GVK</b>	
<b>Capacite Infraprojects</b>	
<b>DLF</b>	
<b>Sun Pharmaceutical</b>	
<b>CBRE</b>	



# Track and Trace-Red

## Quality Policy

**Track and Trace-Red** is a specialized company for Plumbing & Fire fighting work to provide design, installation services for domestic, industrial and commercial building. The fundamental goal is to service and satisfy customer's needs and quality expectations. Measurable objectives are established and subject to review to ensure the quality of services offered by the business conforming to relevant Indian standards.

To provide optimum customer satisfaction, **Track and Trace-Red** technical and office personnel are being conversant with the company's goals and objectives set by the senior management team and Owner. The goal is achieved by

Every employee is determining to maintain quality of works.

Each employee will be responsible for environment safety etc.,

All activities carried out will confirm all contractual requirements specified by the customers are trained with ongoing with necessary skill and knowledge. The staff are committed to maintain and continuous improve the quality system through awareness training, implementation.

The senior management reviews the quality management system to ensure that the system is suitable, adequate and effective. Quality is design for every product and processes achieved jointly by each employee's effort.

The material procured is confirmed to relevant ISI and testing certificates are obtained for each lot.

The work executed is checked thoroughly and tested by instruments.

Mr. TARIK KHAN

*"We believe in Quality Services"*



# Track and Trace-Red

## ENVIRONMENT HEALTH & SAFETY POLICIES

Construction can be dangerous. But when a company really makes a commitment to safety, it can create a workplace in which employees can reasonably expect to have a career free of injury and illness. Track and Trace - Red constantly tightens their safety and health policies demanding that everyone, from upper management to most recently hired trainee, plays an important role in maximizing workplace safety and health. By following set guidelines, such as those outlined in our safety program, the risks of injury or illness are reduced or often eliminated.

Track and Trace - s commitment to safety includes the following:

- ✚ A detailed safety manual with employee training guidelines specified in each program
- ✚ Monthly safety training for foremen
- ✚ Weekly toolbox safety talks at all jobsites
- ✚ Regular jobsite safety inspections

Track and Trace- Red stands behind their belief that we are obligated to provide a safe and healthful workplace, free from any recognized hazards.

\* \* \* ----- \* \* \*



# Track and Trace-Red

## ORGANISATIONAL STRENGTH

	<b>GENERAL MANAGER</b>	1
	<b>MANAGER BUSINESS DEVELOPMENT</b>	1
	<b>TECHNICAL ENGINEERS</b>	3
	<b>FINANCIAL ADVISOR</b>	1
	<b>LIASONING OFFICER</b>	1
	<b>PROJECT MANAGER</b>	3
	<b>MANAGER – PURCHASE</b>	1
	<b>MANAGER – HR</b>	0
	<b>HR EXECUTIVE</b>	0
	<b>DESIGN ENGINEER</b>	1
	<b>DRAUGHTSMAN</b>	2
	<b>ACCOUNTS EXECUTIVE</b>	2
	<b>ENGINEERS</b>	5
	<b>SAFETY ENGINEER</b>	1
	<b>SAFETY OFFICER</b>	3
	<b>SUPERVISOR</b>	6
	<b>STOREKEEPER</b>	2
	<b>CIVIL WORKER</b>	12
	<b>FABRICATING FITTER</b>	4
	<b>WELDER</b>	8
	<b>PLUMBERS</b>	10
	<b>HELPERS</b>	15
	<b>OFFICE ASSISTANT</b>	1



# Track and Trace-Red

## ORGANISATION CHART

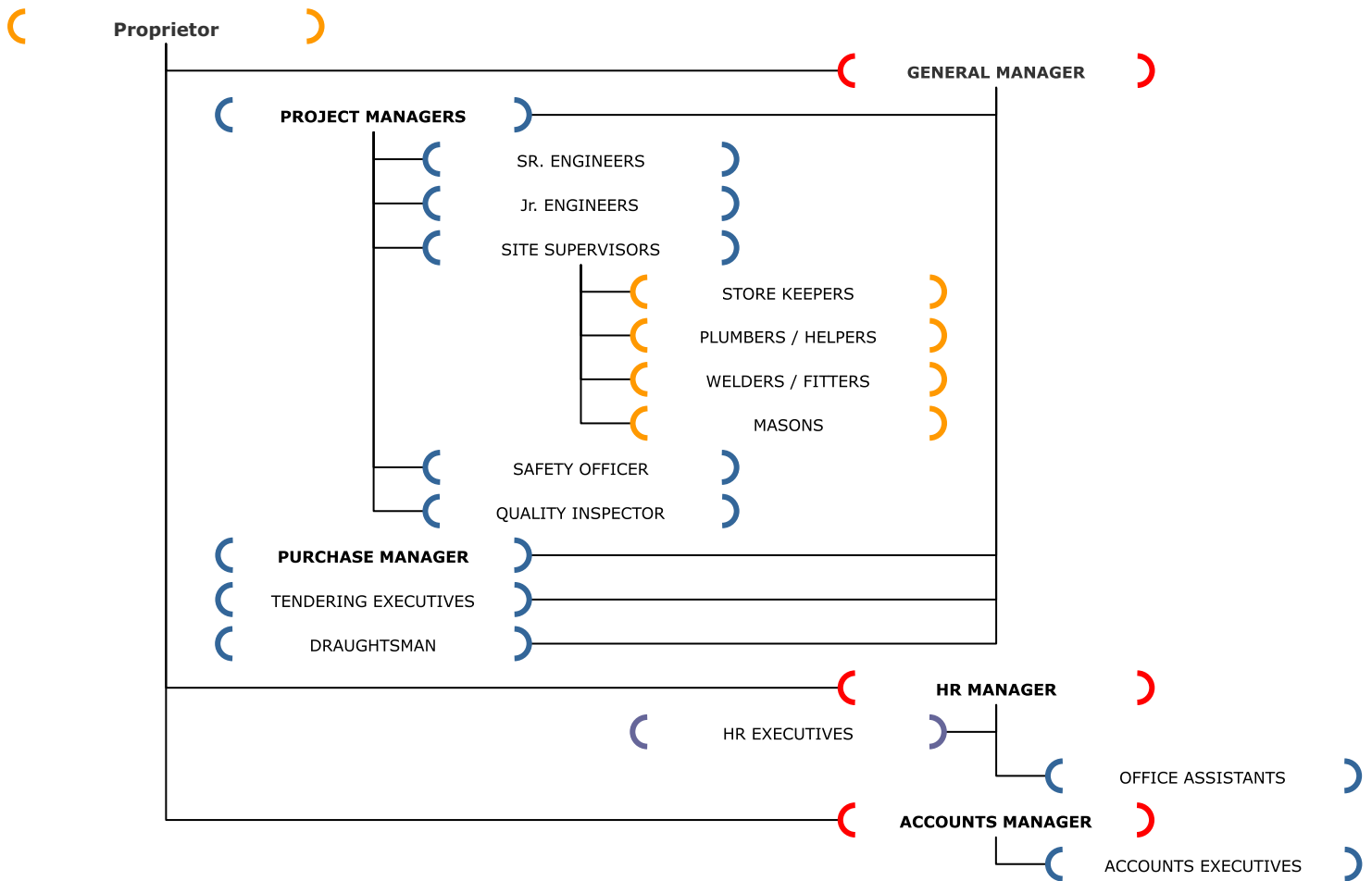

# Track and Trace-Red

## MAJOR PROJECTS COMPLETED

Sr. No.	Nature of Work	Project Cost in Lakhs	Client's Name
	<b>HOTELS &amp; RESORTS</b>		
1	Plumbing & Fire Fighting Works	1136	Taj Santacruz Hotel at Terminal- 1C, Domestic Airport, Mumbai for M/s.Green Woods Palaces & Resorts Pvt. Ltd.) 5 star
2	Plumbing and Fire Fighting Works for Taj Arravalli, Udaipur	488	M/s. Ishaan Group of Clubs and Hotels Pvt. Ltd.
3	Plumbing and Fire Fighting Works for IBIS Hotel, Vikhroli, Mumbai	445	M/s.Isha Steel Treatment Pvt. Ltd.,
4	Plumbing Shaft Renovation Works	409	M/s.Taj President Hotel, Mumbai (PIEM Hotels Ltd.)
5	Plumbing and Fire Fighting Works for IBIS Hotel, Kolkata.	340	M/s. Interglobe Hotels Pvt. Ltd.,
6	Plumbing, Sanitation, water supply & Drainage work.	292	Hotel Park Hyatt project at Hyderabad. (M/s; Gayatri Projects Pvt. Ltd.)
7	Sanitary, Plumbing and Fire Fighting Renovation Work.	285	The Indian Hotels Co. Ltd.- 2 <sup>nd</sup> floor to 19 <sup>th</sup> Floor, Taj Mahal Palace & Tower, Mumbai
8	Restoration of Taj Mahal Hotel after Terrorist Attack- Sanitary, Plumbing and Fire Fighting Work.	243	The Indian Hotels Co. Ltd.- Taj Mahal Palace & Tower, Mumbai
9	Plumbing and Fire Fighting Work.	240	M/s.Sterling Holiday Resorts India Ltd, Wayanad, Kerala.
10	MEP Renovation Work.	236	The Indian Hotels Co. Ltd.-Taj West End, Bangalore – 14 Series
11	Plumbing and Fire Fighting Renovation Work.	180	M/s.Chalet Hotels Pvt. Ltd.,- Hotel Renaissance, Powai, Mumbai.

# Track and Trace-Red

## PICTURE GALLERY



# Track and Trace-Red

## PICTURE GALLERY

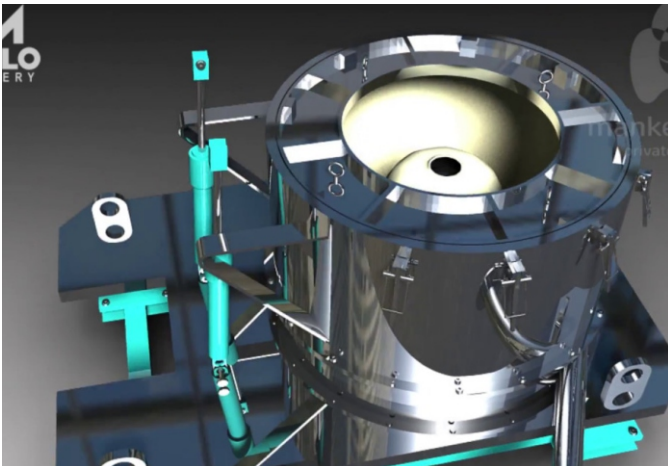
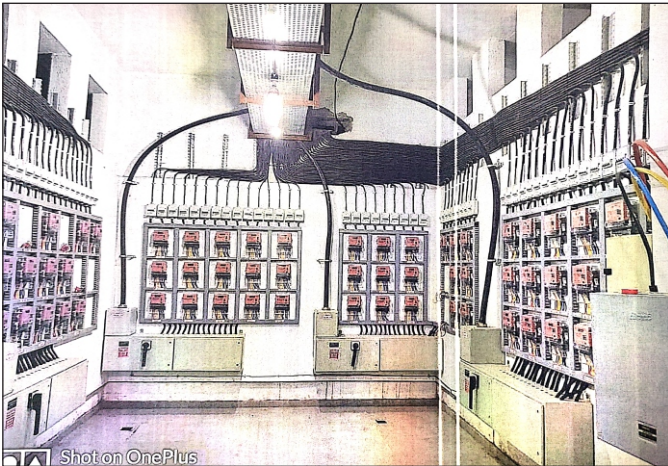

# Track and Trace-Red

## PICTURE GALLERY



# Track and Trace-Red

## PICTURE GALLERY



# Track and Trace-Red

## PICTURE GALLERY



# Track and Trace-Red

## SECURITY SERVICES





# Track and Trace-Red



Thank

You

